



# CLASSIC

10717



 [LEGO.com/classic](https://www.lego.com/classic)







[LEGO.com/brickseparator](https://LEGO.com/brickseparator)



Easy building  
Einfach zu bauen  
Construction facile  
Costruzione facile  
Construcción fácil  
Construção fácil  
Kezdő építőknek  
简单拼砌



Medium building  
Mittelschwer  
Construction intermédiaire  
Costruzione media  
Construcción intermedia  
Construção intermédia  
Gyakorló építőknek  
中级拼砌



Advanced building  
Fortgeschritten  
Construction avancée  
Costruzione avanzata  
Construcción avanzada  
Construção avançada  
Tapasztalt építőknek  
高级拼砌

Page  
Seite  
Pagina  
Página  
Oldalszám  
页码

Page  
**6**



Page  
**14**



Page  
**22**



Page  
**30**



Page  
**38**



  
[LEGO.com/classic](https://www.lego.com/classic)





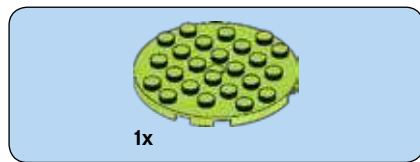

1



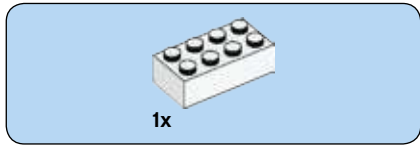

**2**

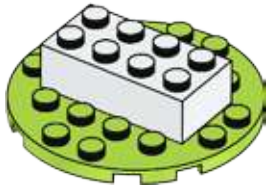

**3**

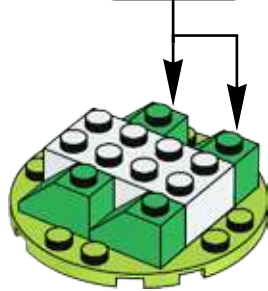

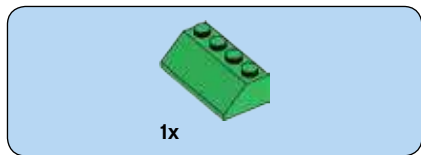

4

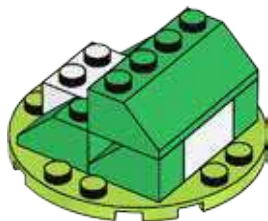





2x

5

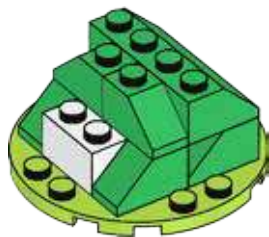

1x

6

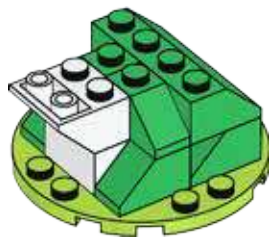



1x

7

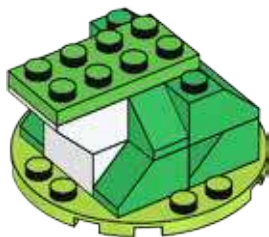



2x

8

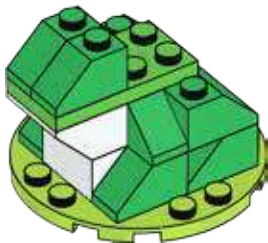

2x



2x

9

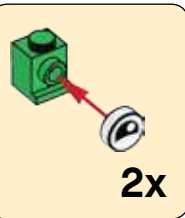

2x

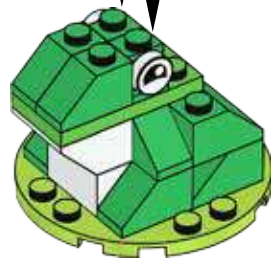



1x

10

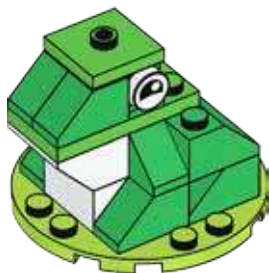



11

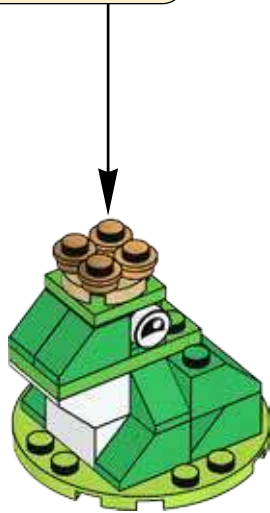

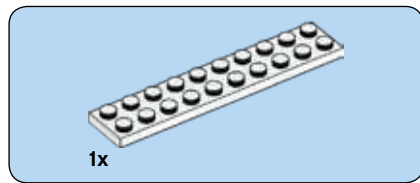

1





1x

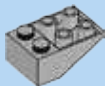

1x

2

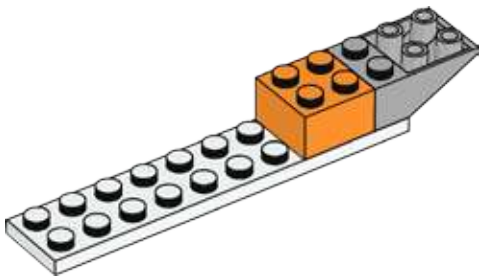





2x

**3**

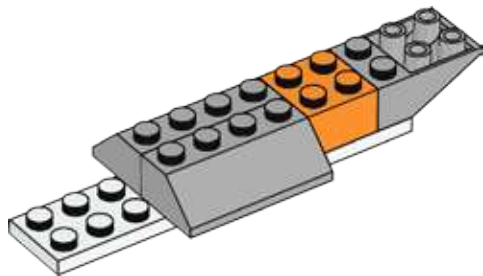

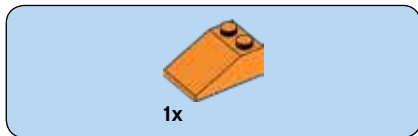

4

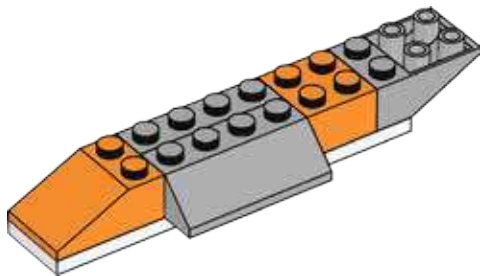

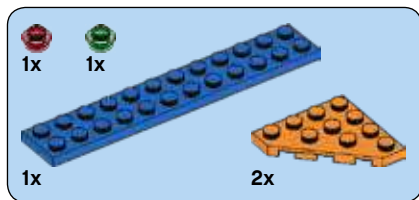

5

1

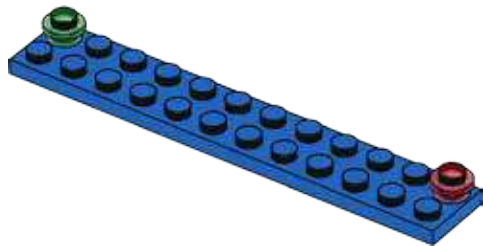

2

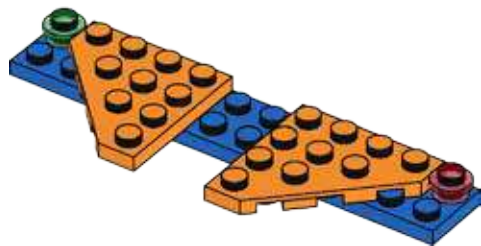

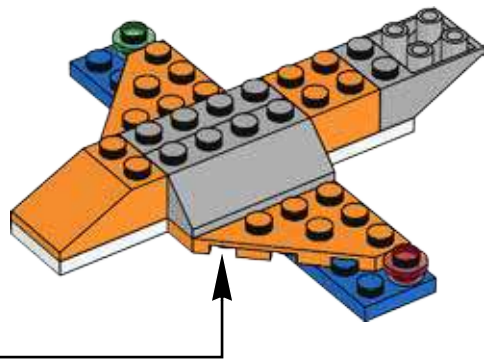

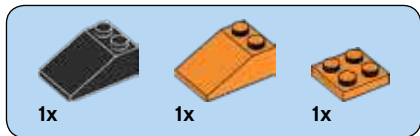

6

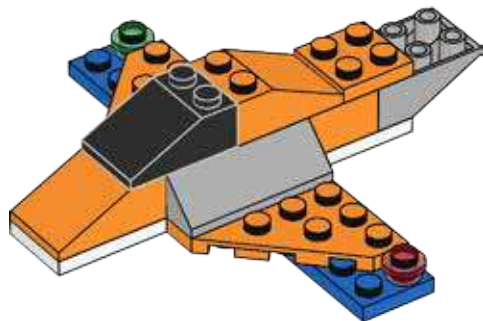

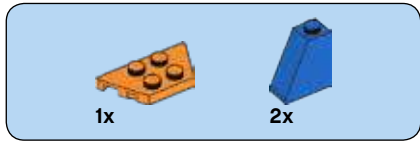

7

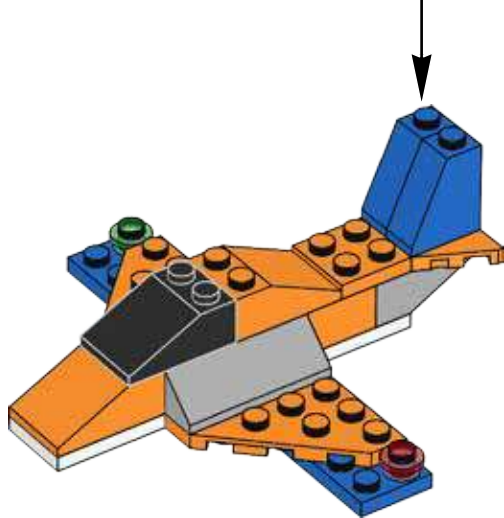
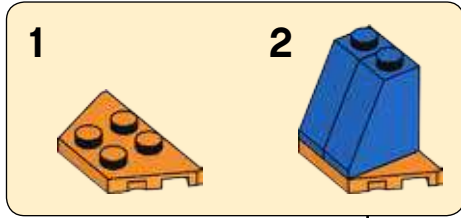

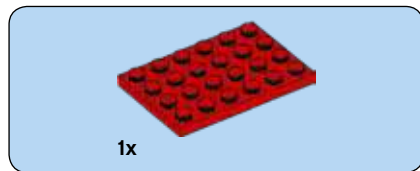

1





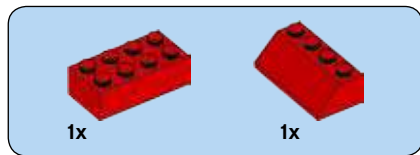

2



3

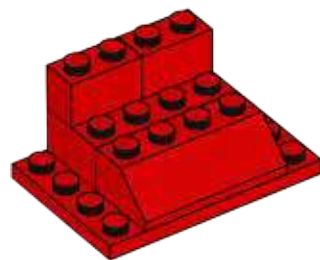



4

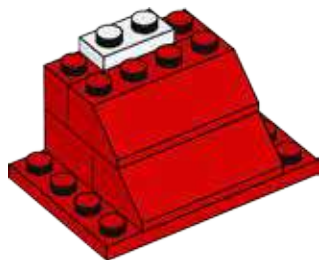

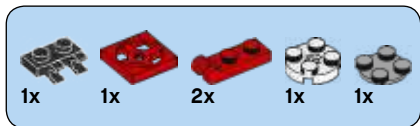

# 5

1



2

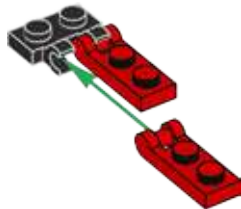

3

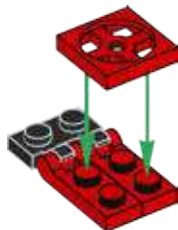

4

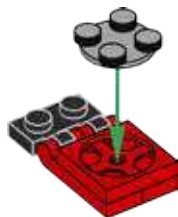

5



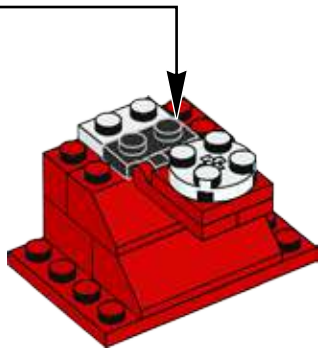

6



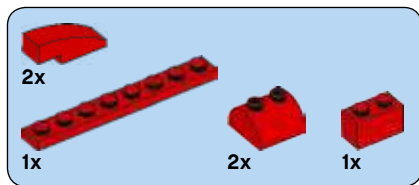

7

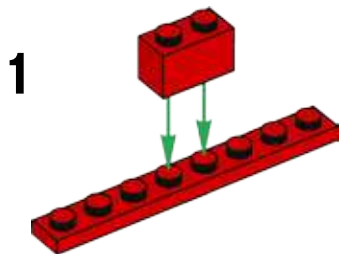

2

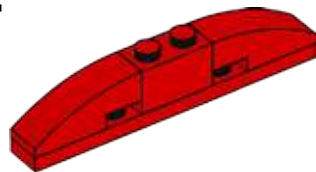

3

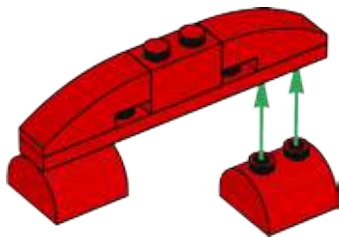



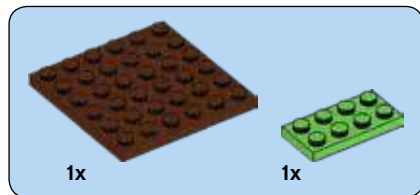

1



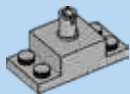

1x

2



2x

3





4x

4



3x



1x

5





4x

6

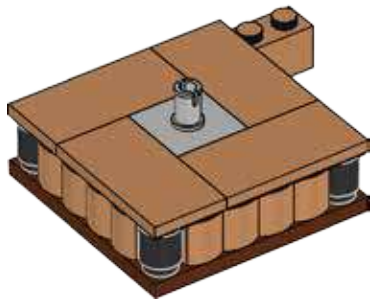

1x

7

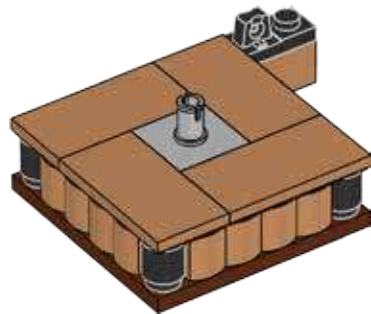

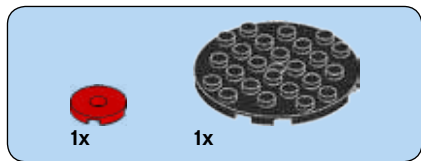

8

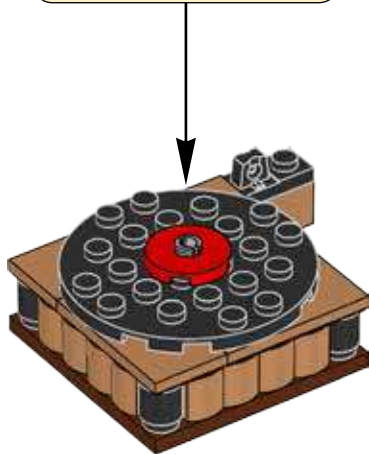
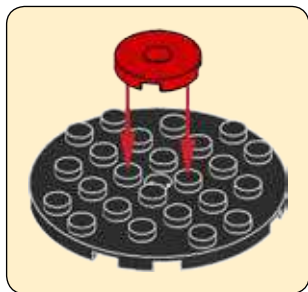

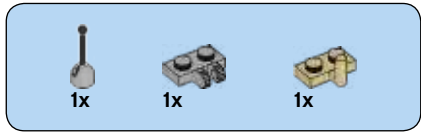

9

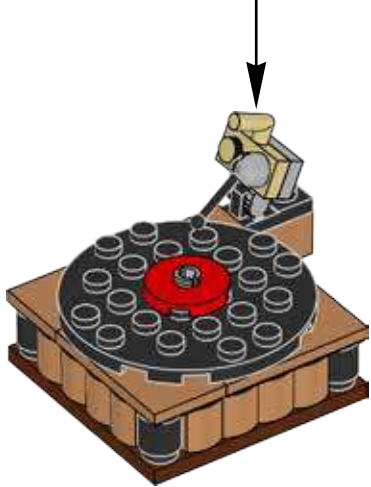
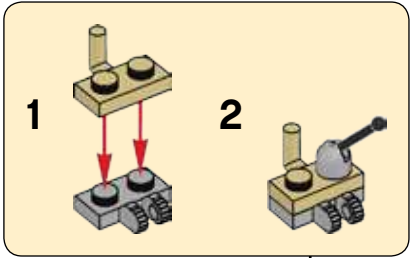



10

1

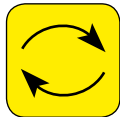

2

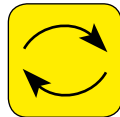

3

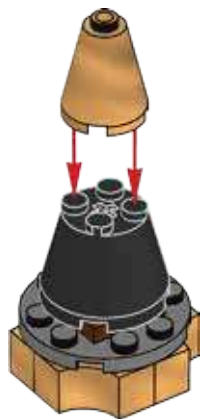

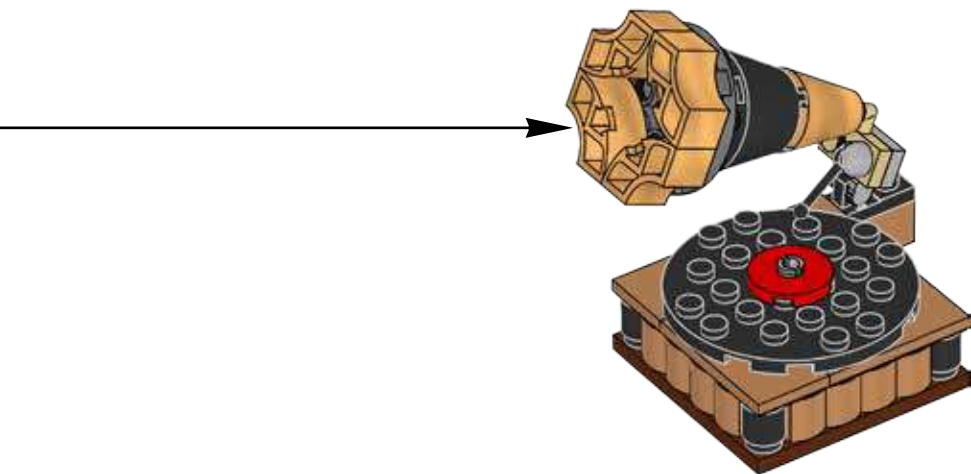



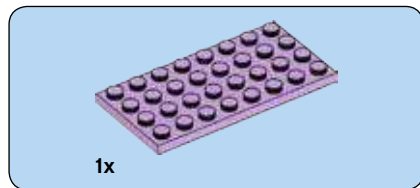

1



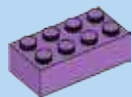

3x

2

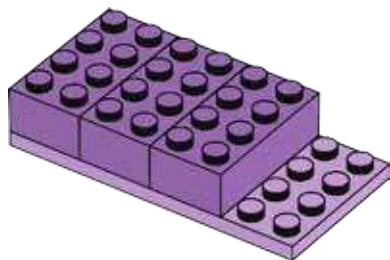

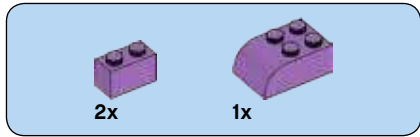

3

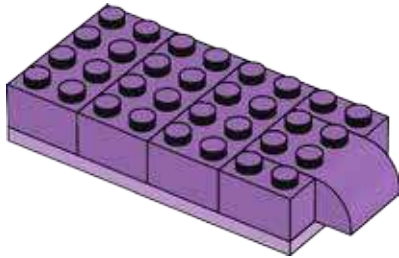

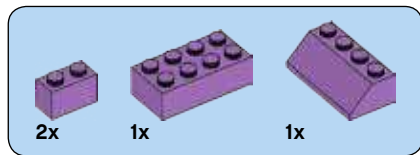

4

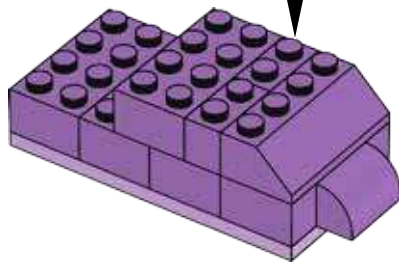
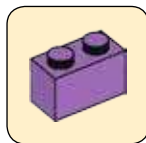

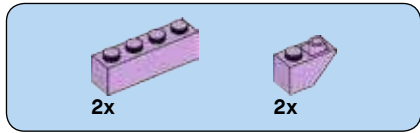

5

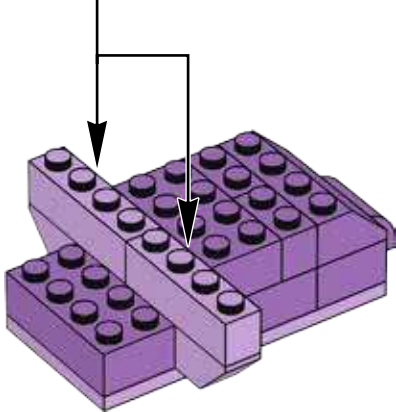
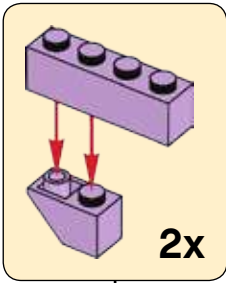

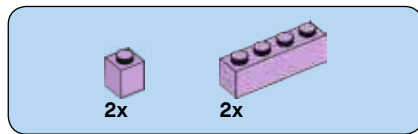

6

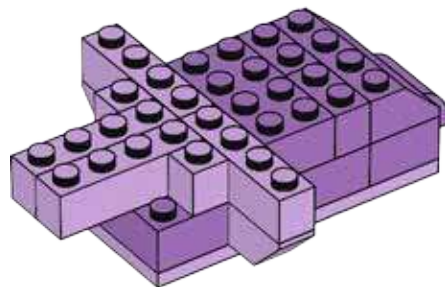

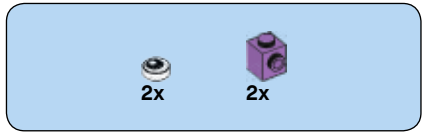

7

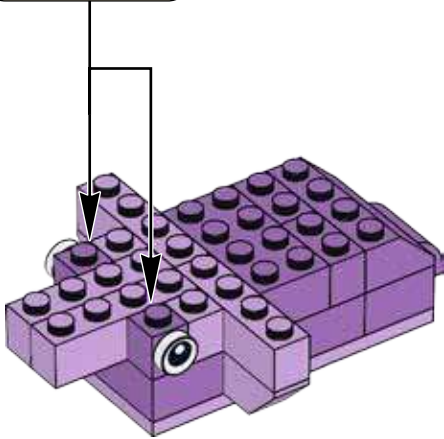
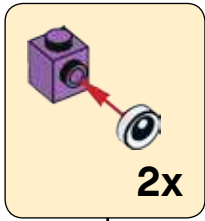



2x



1x

8

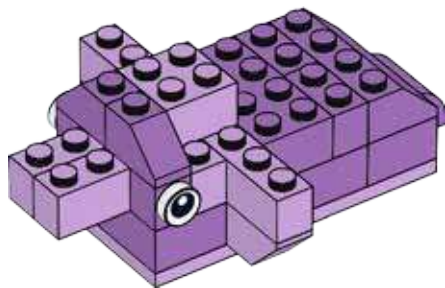



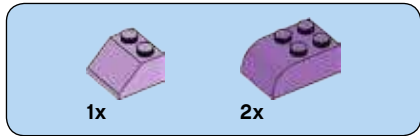

9

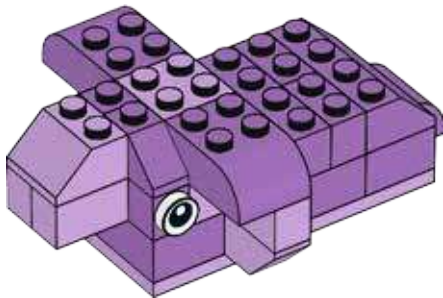



12x

10

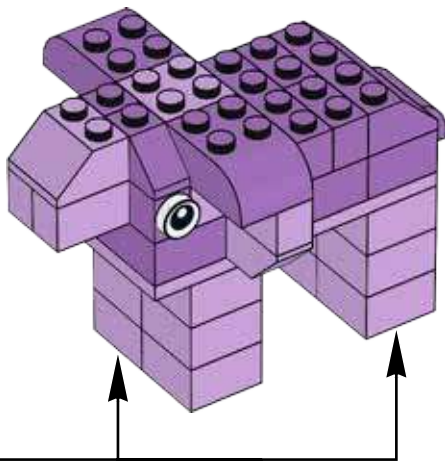
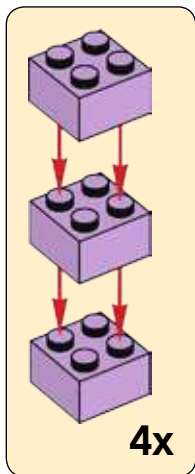

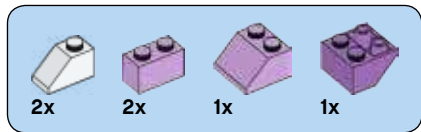

11

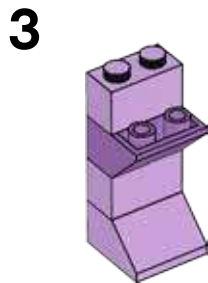
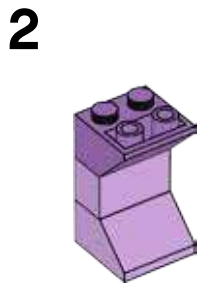
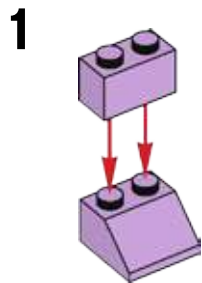

4

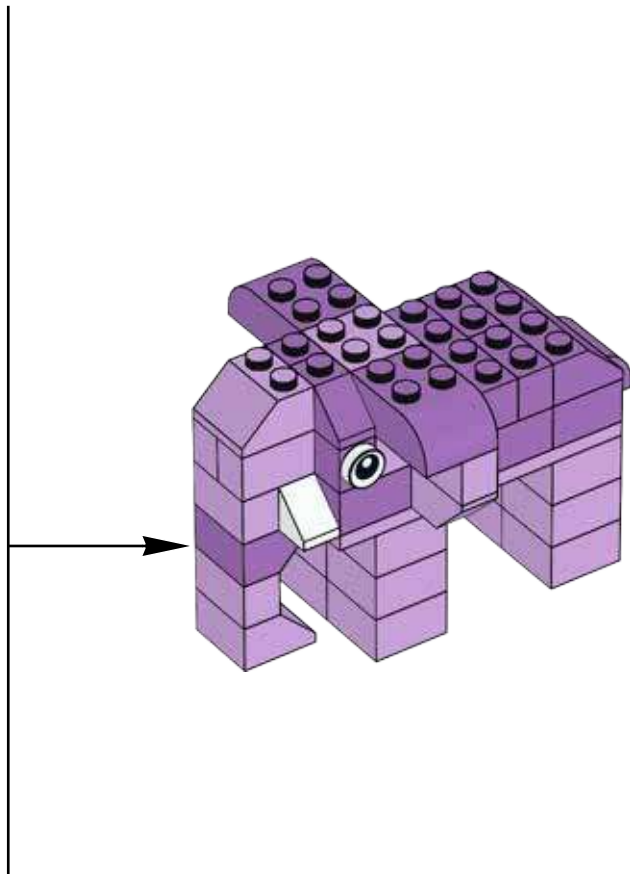
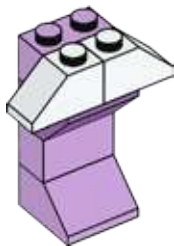



1x

12





2x

13

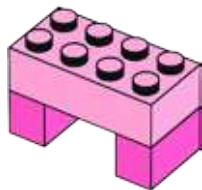

1x

14

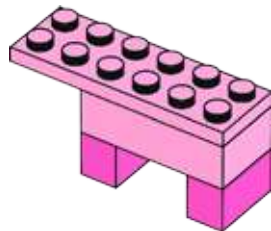



2x



2x

15



2x

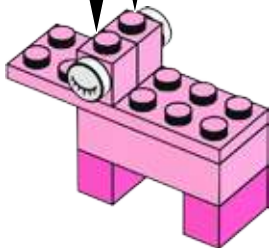



1x



1x

16

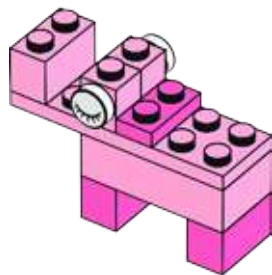



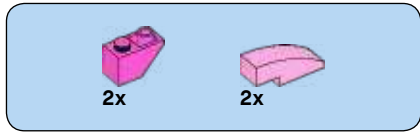

17

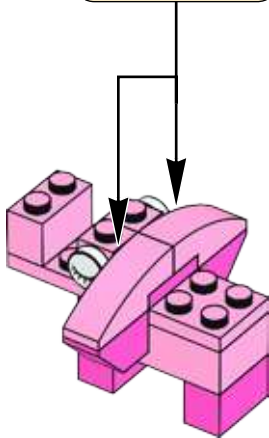
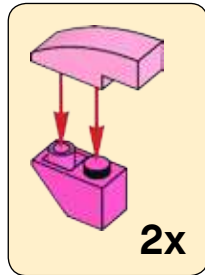

18

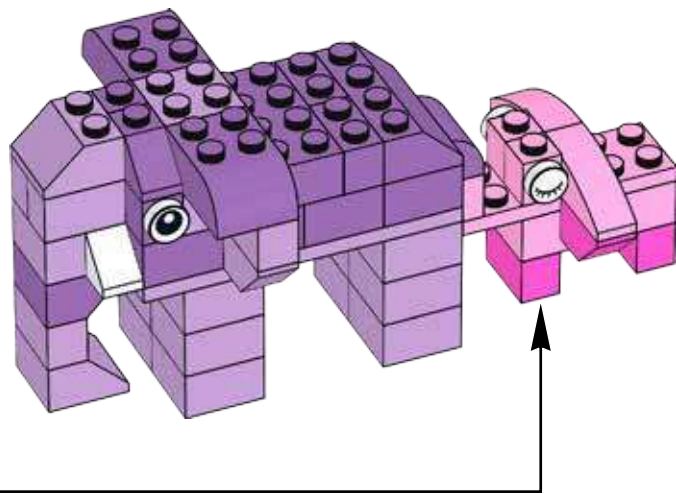

## what will you build to help the baby elephant cross the river?

Was wirst du bauen, um dem Elefantenbaby über den Fluss zu helfen?

Que pourrais-tu bien construire pour aider le bébé éléphant à traverser la rivière ?

Cosa costruiresti per aiutare l'elefantino ad attraversare il fiume?

¿Qué puedes construir para ayudar al bebé elefante a cruzar el río?

O que vais construir para ajudar o elefante bebé a atravessar o rio?

Mit építész, hogy segíts a kiselefántnak átkelni a folyón?

你会拼搭些什么帮助小象跨越河流呢?





10698



10696



10700



10714



10713

10701



[LEGO.com/classic](https://www.lego.com/classic)





# CREATOR™

# 3 IN 1



3 in 1  
3 en 1  
3 em 1  
3 az 1-ben  
3 合 1

31077



8x  
306201



4x  
6099548



4x  
6029156



4x  
6097402



4x  
6194809



4x  
4558952



4x  
4170457



4x  
403201



4x  
4547489



8x  
302301



8x  
300401



6x  
446001



2x  
6153776



4x  
4121932



8x  
300301



4x  
366001



4x  
362201



1x  
4541956



3x  
4530590



4x  
302001



8x  
300101



2x  
4181142



1x  
383201



1x  
4514842

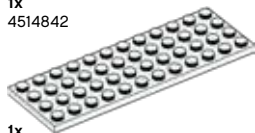

1x  
4168072



6x  
4118793



4x  
4140562



4x  
4125220



36x  
4109995



4x  
4655257



20x  
4162465



4x  
4118790



4x  
4500453



8x  
4159739



2x  
4550323



3x  
4114309



3x  
4112982



4x  
4529234



8x  
300521



2x  
6102138



16x  
300421



2x  
370021



4x  
4121934



2x  
368021



4x  
4521852



4x  
4515365



8x  
362221



4x  
362321



4x  
4251162



8x  
303721



4x  
300121



2x  
346021



2x  
303221



4x  
459923



8x  
300523



4x  
6189189



4x  
6055065



8x  
366523



4x  
4514398



4x  
302123





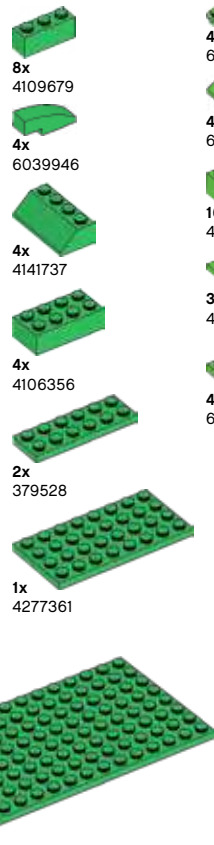
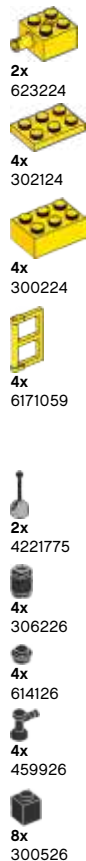

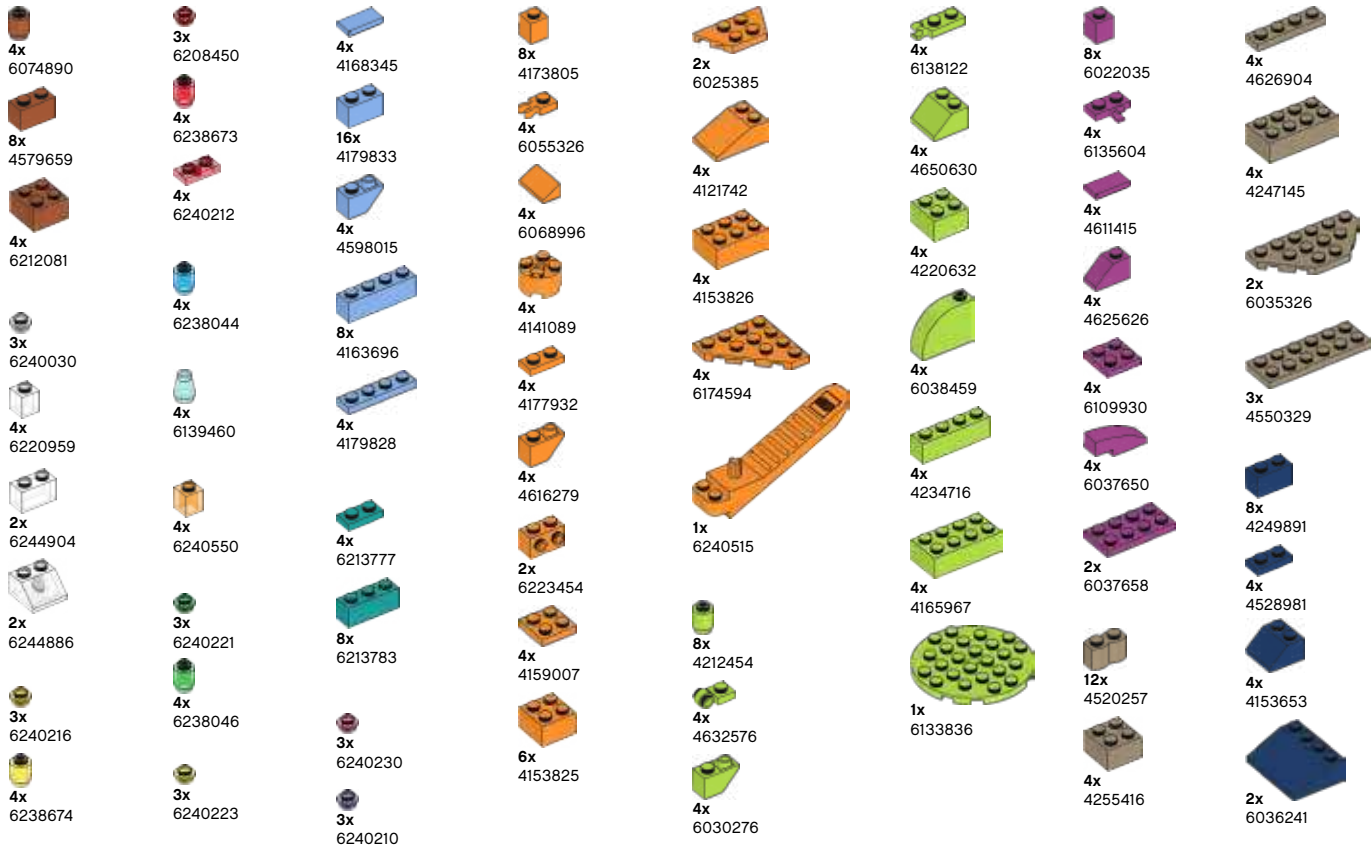

























































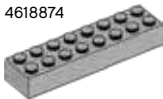









4x  
300223







 8x 4245570	 8x 4541376	 4x 6122504	 4x 4529242	 4x 4216668	 12x 4211389	 2x 4211570	 4x 4529240
 4x 6003331	 4x 4541506	 4x 6170916	 3x 4216581	 2x 6153594	 2x 4540203	 4x 4211394	 3x 4210633
 4x 6214611	 4x 4539097	 4x 6061688	 4x 4223303	 4x 6096217	 4x 4617170	 2x 4211409	 8x 4558955
 4x 4616578	 4x 4613761	 4x 6022064	 4x 6069984	 4x 6096217	 4x 6000066	 2x 4211409	 4x 4210636
 4x 6186823	 4x 4609925	 4x 6020073	 4x 4629736	 4x 4538252	 4x 4515341	 1x 4211666	 8x 4211063
 4x 6075624	 4x 4539104	 4x 6100027	 4x 4211149	 1x 4217848	 4x 4211350	 2x 4618874	 4x 4211043
 4x 6100234	 4x 6004938	 4x 6100027	 4x 4216695	 2x 6096716	 4x 6198932	 2x 6037399	 2x 4528323
 3x 6240227	 8x 6004943	 4x 6182777	 12x 4211221	 4x 6022032	 4x 4645397	 4x 6022105	 4x 4211085
	 4x 6151671	 4x 6132418	 2x 6050918	 4x 6192270	 2x 4211504	 4x 6092677	 4x 6036232
	 8x 6036851		 4x 4211220				

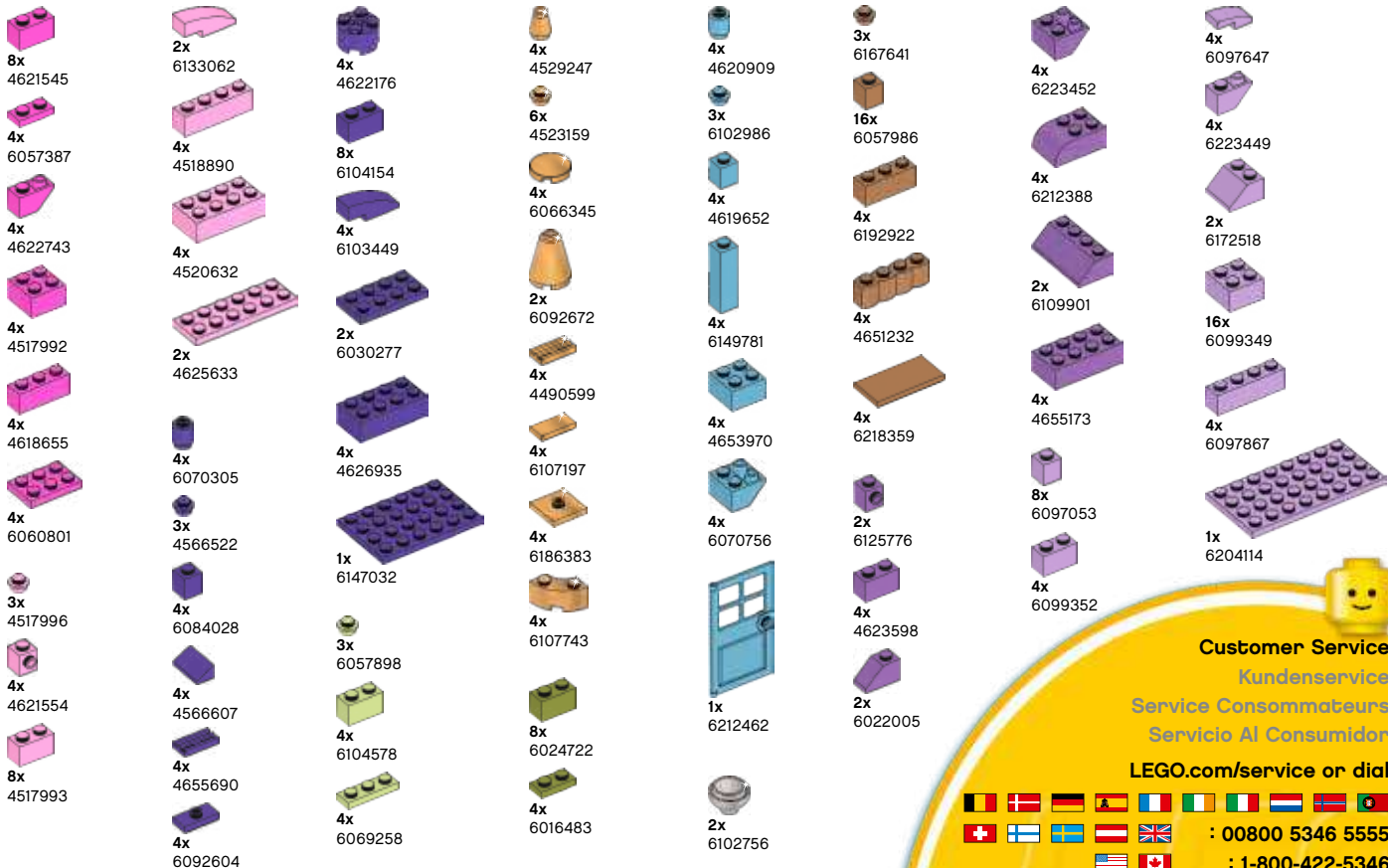

**Customer Service**

**Kundenservice**

**Service Consommateurs**

**Servicio Al Consumidor**

**LEGO.com/service or dial**



**: 00800 5346 5555**

**: 1-800-422-5346**

# WIN

GO TO [WWW.LEGO.COM/PRODUCTFEEDBACK](http://WWW.LEGO.COM/PRODUCTFEEDBACK) AND  
GIVE US YOUR SHORT **FEEDBACK** ABOUT THIS  
LEGO® SET FOR A CHANCE TO WIN  
A COOL LEGO PRIZE.

Terms & Conditions apply

## LEGO.com/productfeedback



### GEWINNE

Erzähle uns auf  
[www.LEGO.com/productfeedback](http://www.LEGO.com/productfeedback)

etwas über die Erfahrungen, die du mit  
diesem LEGO® Set gemacht hast, und  
sichere dir die Chance auf einen coolen  
LEGO Preis!

Es gelten die Teilnahmebedingungen

### GAGNE

Rends-toi sur  
[www.LEGO.com/productfeedback](http://www.LEGO.com/productfeedback)

et donne-nous quelques commentaires sur  
ce produit LEGO® pour avoir une chance  
de gagner un prix LEGO !

Voir Conditions Générales

### GANAN

Visita  
[www.LEGO.com/productfeedback](http://www.LEGO.com/productfeedback)

y envíanos tu opinión acerca de este set  
LEGO®. ¡Participarás en el sorteo de un  
premio LEGO!

Términos y Condiciones aplicables

### 获取奖品

登录  
[www.LEGO.com/productfeedback](http://www.LEGO.com/productfeedback)

给出关于此乐高®套装的简短反馈，  
就有机会获得炫酷乐高奖品

《条款及条件》适用

LEGO and the LEGO logo are trademarks of the LEGO Group. ©2018 The LEGO Group.

6242580